

The Semantics of Temporal Adjuncts

Ness Schelkens, Frank Van Eynde and Sven Verdoolaege

Centre for Computational Linguistics and Department of Computer Science
K.U.Leuven

Abstract

In this article, we present some work that was conducted within the framework of Linguaduct, a project in which we are trying to model the temporal interpretation of Dutch text.

Next to verbs, temporal adjuncts are the most important source of explicit information about the temporal properties of the eventualities that are being described in a text. We will show how a DRT-style eventuality-based semantic analysis of tense, aspect and temporal modification can be integrated within standard HPSG.

Second, we propose to represent the semantics of the different kinds of temporal adjuncts up to a rather fine-grained level of decomposition. As will be illustrated, some facts about the interaction of temporal modification with tense, and about the combination of different adjuncts, naturally fall out of our analysis.

1 Conceptual framework

Our conceptual framework for the representation of the semantics of tense, aspect and temporal modification is largely the same as what can be found in Kamp & Reyle 1993.

Eventualities (Bach, 1981) are considered primitives. We distinguish between three (instead of Kamp & Reyle's two) aspectual types of eventualities on the basis of the properties *stative* vs. *dynamic* on the one hand, and *telic* vs. *atelic* on the other.

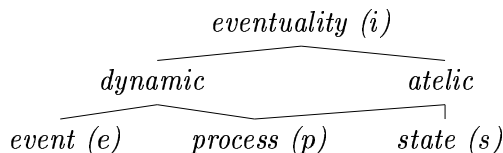

With every eventuality we associate an *eventuality time*, which embodies the temporal di-

mension of the eventuality. Kamp & Reyle do not make use of such an eventuality time, although it could be argued that it is implicitly present.

Furthermore, we follow the DRT-practice in letting every eventuality introduce its own *location time*. The location time of an eventuality is the temporal index with respect to which the eventuality is located, or—more succinctly—it is a temporal anchor for the eventuality. At least in the matters we are concerned with in this article, the location time is comparable to the *reference time* that Partee (1984) and Hinrichs (1986), amongst others, make use of.

Finally, we also adopt Kamp & Reyle's *temporal perspective time*. However, as the temporal perspective time is almost always identified with the utterance time, except for a few phenomena which do not concern us here (i.e. transposition, flashbacks), we will not refer to it here, and only talk about the *utterance time*.

2 Temporal semantics within HPSG

To ensure a close correspondence between the text and its semantic representation, we want to try and incorporate our account of tense, aspect and temporal modification within HPSG (as presented in Pollard & Sag 1994). After all, HPSG is explicitly equipped to represent and combine information of a syntactic, semantic and even pragmatic nature alike. That a formal structure which does justice to all these different aspects of a text can be built up, has already been demonstrated, for example by Green (1994), who presents an HPSG analysis of phenomena like extended reference and Japanese empathy-sensitive verbs, and by Engdahl (1999), who shows how an analysis of focus can be integrated in HPSG.

In order to be able to represent temporal

information, we let a substantive verb introduce a referential index (i), much like has been done before by Kasper (1994), among others.¹ This referential index roughly corresponds to a Davidsonian event variable, or a Kamp & Reyle discourse referent for an eventuality. The eventuality index belongs in the CONTENT value of the verb, as it is *explicitly* introduced in the discourse.

CAT	$\left[\begin{array}{l} \text{HEAD}_{verb} [\text{VFORM } verbform] \\ \text{ARG-ST} \langle \text{NP}_{[1]}, \text{NP}_{[2]} \rangle \end{array} \right]$
CONT NUCL	$\left[\begin{array}{l} \text{INDEX } [z] \text{ ref} \\ \text{RESTR} \left\{ \begin{array}{l} \text{INST } [i] \text{ ref} \\ \text{OWNER } [1] \\ \text{OWNED } [2] \end{array} \right\} \text{at} \left[\begin{array}{l} \text{INST } [i] \\ \text{TEMP } [z] \end{array} \right] \end{array} \right]$
CONTEXT	$\left[\begin{array}{l} \text{C-INDICES} \left[\begin{array}{ll} \text{UTT-LOC} & [z] \text{ ref} \\ \text{SPEAKER} & \\ \text{ADDRESSEE} & \\ \text{EVT-TIME} & [z] \\ \text{LOC-TIME} & [i] \text{ ref} \end{array} \right] \\ \text{BACKGROUND} \{ [z] \text{ REL } [1], [1] \text{ REL } [z] \} \end{array} \right]$

The location time (t) is also represented as a referential index, but one pertaining to a *time* rather than to an eventuality. It is, like the indices for utterance time and speaker, introduced in the CONTEXT|C-INDICES value of the verb, as it constitutes part of the frame of reference with respect to which the discourse is interpreted, rather than actual discourse content.

In the CONTENT value, the eventuality index is related to its temporal location (z), which represents its temporal properties and which is unified with the contextual index representing the eventuality time.

The semantic contribution of the tense is represented by the CONTEXT|BACKGROUND restrictions. They impose a certain relation between the eventuality time introduced by the verb and the utterance time, through mediation of the location time. The representation for a tensed form of the verb *bezitten* (*to own*) above shows schematically the AVM that results.

As for the temporal adjuncts, they introduce in their CONTENT value a referential index de-

noting the period of time they refer to and some restrictions on this index, as well as restrictions on one or more of the indices introduced by the verb that is being modified. As an example, here is a preliminary representation for the adjunctive use of *gisteren* (*yesterday*).

LEX-GISTEREN-ADJ

CAT HEAD	$\left[\begin{array}{l} \text{MOD} \left[\begin{array}{l} \text{CAT HEAD } verb \\ \text{CONX C-INDS LOC-TIME } [1] \end{array} \right] \end{array} \right]$
CONT	$\left[\begin{array}{l} \text{INDEX } [z] \text{ ref} \\ \text{RESTR} \left\{ yesterday \left[\text{INSTANCE } [z] \right] \right\} \end{array} \right]$
CONX	$\left[\begin{array}{l} \text{C-INDS UTT-LOC } [z] \\ \text{BACK} \{ [1] \subseteq [z], [z] < [1] \} \end{array} \right]$

For the compositional aspect of the semantics, we assume, like in Sag and Wasow 1999 (p. ???), that the CONTENT—RESTR value of a head-adjunct combination is determined by simply taking the union of the respective CONTENT—RESTR values of head and adjunct.

Note that there is also a lexical entry for the non-adjunctive uses of *gisteren* (and other nouns like it) which occur in (1), (2) (both as the argument to a preposition) and (3) (as the subject), for example. It will be essentially the same as the one for the adjunct use, except that there is no MOD value, and that no relation between the time indicated by the noun and the location time of the eventuality introduced by the verb is specified.

- (1) Ik heb de krant van gisteren.
I have the newspaper of yesterday
“I have yesterday’s newspaper.”
- (2) Voor gisteren wist ik dat niet.
before yesterday knew I that not
“Before yesterday, I did not know that.”
- (3) Gisteren was de warmste dag ooit.
yesterday was the hottest day ever
“Yesterday was the hottest day ever.”

With respect to the question of what has to go into the CONTENT feature, and what into the CONTEXT value, we simply use the following rule of thumb: all constraints on indices which are not explicitly referred to by means of a linguistic sign, belong in the CONTEXT

¹For the substantive/nonsubstantive distinction, see Van Eynde 1998 and Van Eynde 2000.

value. The Principle of Contextual Consistency makes sure that this information is passed up to sentence level, and thus remains available for processing further on in the discourse. But we stress that this is a rather pragmatic criterion, and that it probably should be replaced with a theoretically better underpinned one.

For more details about the grafting of a DRT-like analysis of tense and aspect onto HPSG, see Van Eynde 1998 and 2000.

3 The semantic decomposition of temporal adjuncts

Traditionally (Bennett and Partee 1987, Binnick 1991, a.o.), temporal adjuncts are categorized according to the fundamentally different ways in which they are perceived to modify the eventualities introduced by verbs:

- **frame or locating adjuncts:** indicate when the eventuality occurs, e.g. *gisteren* (*yesterday*), *om twee uur* (*at two o'clock*), *in 1987*.
- **durational adjuncts:** express either the interval during which the eventuality holds, or the interval that leads up to the occurrence of the eventuality, e.g. *drie uur lang* (*for three hours*), *een minuutje* (*for a minute*), *in een oogwenk* (*in an instant*), *in minder dan een uur* (*in less than an hour*).

Sometimes, a third type of adjuncts is considered to be of a temporal nature as well:

- **frequency adjuncts:** specify how frequently an eventuality takes place, e.g. *dagelijks* (*daily*), *tweemaal per maand* (*twice a month*), *elke winter* (*every winter*), *vaak* (*often*).

We will not discuss this third class of adjuncts here.

The rather simple and intuitive classification presented above does not do justice to the great variety in ways in which temporal adjuncts are able to modify eventualities. This becomes clear very quickly when one tries to represent the meaning of different temporal adjuncts at a detailed level of decomposition, as we will do in the remainder of this article.

A representation like the one for *gisteren* shown in section 2 is not a particularly rich

basis for the reasoning that we assume to be involved in the complex process of text interpretation. Actually, except for the fact that the relation value would be different, the representation for *eergisteren* (*the day before yesterday*) would look exactly the same. Compare, however, the representation of *gisteren* in section 2 with a representation like the following:

LEX-GISTEREN-ADJ

$$\left[\begin{array}{l} \text{CAT | HEAD} \left[\begin{array}{l} \text{MOD} \left[\begin{array}{l} \text{CAT | HEAD } \textit{verb} \\ \text{CONX | C-INDS | LOC-TIME } \boxed{t} \end{array} \right] \\ \textit{noun} \end{array} \right] \\ \text{CONT} \left[\begin{array}{l} \text{INDEX } \boxed{x} \\ \text{RESTR } \left\{ \textit{day} \left[\text{INSTANCE } \boxed{x} \right] \right\} \end{array} \right] \\ \text{CONX} \left[\begin{array}{l} \text{C-INDS | UTT-LOC } \boxed{u} \\ \text{BACK } \left\{ \textit{day} \left[\text{INST } \boxed{d}, \boxed{u} \subseteq \boxed{d}, \boxed{t} \subseteq \boxed{x}, \right. \right. \\ \left. \left. \boxed{x} = \boxed{d} - 1 \right\} \end{array} \right] \end{array} \right]$$

The meaning of *gisteren* is further broken down into the constraints that the adjunct refers to a day (x) and that this day is temporally situated one unit in the past from today, or rather, the day (d) on which the utterance takes place. The specific format of the last constraint goes back to Blackburn 1994.

Described in this way, the semantic differences between temporal adjuncts are made explicit. At a later stage, this detailed information can be meaningfully combined with knowledge about the way our calendar is organized, about the particular moment the discourse is taking place, etcetera. Moreover, we will show in this article that this way of representing the properties of temporal adjuncts proves useful already at sentence level.

4 Locating adjuncts

4.1 Deictic, anaphoric or independent?

Within the general category of the locating adjuncts, which provide a further specification of *when* the eventuality occurs, we first of all have to distinguish between the following kinds:²

- **deictic adjuncts:** their interpretation is dependent upon the utterance time

²See also Smith 1981 and Oversteegen 1988, a.o.

- **anaphoric adjuncts:** their interpretation is dependent upon some previously specified anchor time
- **independent adjuncts:** they refer directly to the time axis

One could say that these specific classes of adjuncts differ with respect to the way their index is related to the time axis: either directly (independent adjuncts), or indirectly, via the utterance time (deictic adjuncts) or via some other temporal anchor (anaphoric adjuncts). These differences are naturally reflected in our analysis.

4.1.1 Deictic adjuncts

An example representative for the deictic adjuncts has already been given in the previous section: *gisteren* (*yesterday*). Other adjuncts in this category are *vandaag* (*today*), the adjuncts with *volgende* (*next*) and *vorige* (*last*), and adjuncts with prepositions like *over* (*within*) or an adverb like *geleden* (*ago*) as a head. Central to the meaning of all of these is that a restriction is placed on the relation between the index pertaining to the period of time introduced by the adjunct and the index standing for the utterance location.

The infelicity (indicated by when the representation of the adjunct is combined with a representation of the meaning of the future *zullen*.

- (4) % Ik zal gisteren oma bellen.
 I will yesterday granny call.
 “I will call granny yesterday.”

Assuming the future *zullen* situates the location time of the calling somewhere *after* the utterance time, the combination with *gisteren* is discarded by some post-grammatical pragmatic module, because conflicting CONTEXT|BACKGROUND constraints are imposed.

On the other hand, the fact that *vandaag* (*today*) can be freely combined with all kinds of tenses, is explained just as easily. We suggest that *vandaag* has the following lexical representation for its adjunctive use.

This representation shows clearly that *vandaag* is a deictic adjunct as defined above: its referent is identified on the basis of the information that it is the day on which the utterance

$$\left[\begin{array}{l} \text{CAT | HEAD} \left[\begin{array}{l} \text{MOD} \left[\begin{array}{l} \text{CAT | HEAD } \textit{verb} \\ \text{CONX | C-INDS | LOC-TIME } \boxed{t} \end{array} \right] \\ \textit{noun} \end{array} \right] \\ \text{CONT} \left[\begin{array}{l} \text{INDEX } \boxed{x} \\ \text{RESTR } \left\{ \textit{day} \left[\text{INSTANCE } \boxed{x} \right] \right\} \end{array} \right] \\ \text{CONX} \left[\begin{array}{l} \text{C-INDS | UTT-LOC } \boxed{u} \\ \text{BACK } \{ \boxed{u} \subseteq \boxed{x}, \boxed{t} \subseteq \boxed{x} \} \end{array} \right] \end{array} \right]$$

takes place, i.e. its referent is the time period of a day in whose index the referential index for the utterance location is included. The relation between the index of *vandaag* and the verb’s location time, however, is inclusion as well, leaving the relation between location time and utterance time for further specification by the tense.

4.1.2 Anaphoric adjuncts

The meaning of anaphoric adjuncts like *die ochtend* (*that morning*), *twee weken later* (*two weeks later*) and *een paar uur daarvoor* (*a few hours before that*) invariably involves—quite contrary to the meaning of deictic adjuncts—reference to a time which is specifically *not allowed* to stand in a certain relation to the index for the utterance time. Take for example the representation for *die dag* (*that day*):

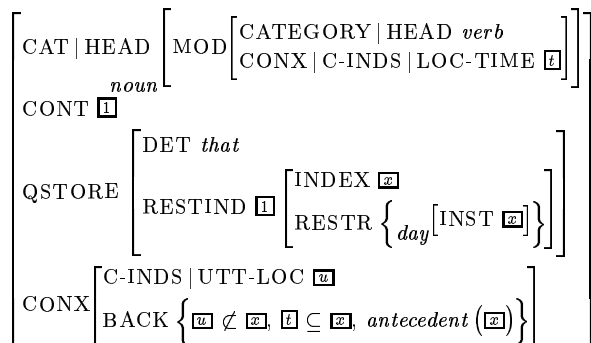

Notice that we associate a special predicate *antecedent* with anaphoric adjuncts such as *die dag*. The occurrence of this predicate will trigger a post-grammatical module to go looking for its antecedent somewhere within the context of the sentence, that is, somewhere within the information provided by earlier sentences or world knowledge. The search will depend on some default specifications of what kind of hypothesis to try first, and some rules for accommodation of what is not represented explicitly in the knowledge-base as well.

Again, an interesting interaction with tense can be observed: assuming the present tense standardly means something like ‘non-precedence of the location time with respect to the utterance time’, the following sentence automatically gets a futurate interpretation:

- (5) Ik koop het geschenk die dag.
I buy the present that day
“I will buy the present that day.”

Because the meaning of *die dag* precludes it from referring to today, the interpretation of the present tense which situates the location time of the buying at the utterance time is rejected, and a futurate interpretation, situating the location time after the utterance time, is enforced.

4.1.3 Independent adjuncts

Independent adjuncts (for example *in 1987*, *in de 21ste eeuw* (*in the 21st century*), *op 23 mei 2000* (*on May 23, 2000*)), finally, are the simplest, as they are able to specify a relation with the time axis all by themselves. No special constraints expressing relations with other temporal anchors are needed.

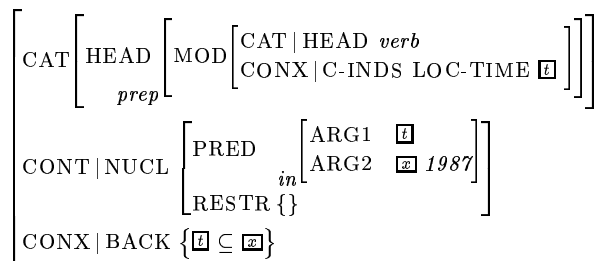

The location time of the verb being modified is simply said to fall somewhere within the temporal extension of the index provided by the syntactic argument of the preposition, 1987 (x).

Note however, that a great number of adjuncts which are all too often classified as being *independent* or *absolute*, in reality are not. An adjunct like *10 juli* (*the 10th of July*), for instance, is dependent upon the utterance time (in its deictic meaning) or some other temporal index (in its anaphoric use) for resolving which year is being referred to.

Our way of representing the independent adjuncts makes clear why there is a difference in acceptability between (4) and (6).

- (6) Ik zal in 1987 een nieuwe auto kopen.
I will in 1987 a new car buy
“I will buy a new car in 1987.”

While (4) seems awkward right away, the appropriateness of (6) seems to hinge crucially on knowledge about when the utterance is taking place. The only constraints that are being imposed on the BACKGROUND are, that the location time has to follow the utterance time, and that the location time has to be included in the extension of *in 1987*. Whether this is indeed the case, is a truly contingent matter, depending on world-knowledge. So, while the pragmatic module will reject (4) on the basis of the internal inconsistency of the CONTEXT—BACKGROUND value, (6) will be discarded only if the BACKGROUND value proves inconsistent with the world knowledge present.

4.2 The relation between adjunct and location time

Next to the categorization on the basis of the way in which the relation between the index of

the time period introduced by the adjunct and the time axis is imposed, there is another line along which the category of locating adjuncts can be divided. It concerns the nature of the relation between the index introduced by the adjunct and the location time of the verb.

4.2.1 Inclusion

For the majority of locating adjuncts, we would say, that relation is inclusion. A good example is, once again, *gisteren* (*yesterday*). The location time of the verb is restricted to be temporally included in the period of time denoted by *gisteren*. This type of adjuncts can truly be called *frame adjuncts*, as they create a frame around the verb's location time.

To avoid misunderstandings, let us explain here that in our analysis, it is not the adjunct, but a rather general constraint on the relation between the location time and the eventuality time which is responsible for the contrast between (7) and (8):

- (7) Ik was ziek gisteren.
I was ill yesterday.
"I was ill yesterday."
- (8) Ik kocht gisteren nieuwe schoenen.
I bought yesterday new shoes
"I bought new shoes yesterday."

In (7), we interpret the temporal relation between the *state* of being ill and yesterday as being one of mere overlap: on the one hand, one can faithfully utter (7) if one is ill during only a part of yesterday; on the other hand, (7) is just as well compatible with situations in which one became ill before yesterday, or where one is still ill at utterance time. Sentence (8) situates the whole of the buying *event* within yesterday. This difference is preserved if the information provided by the adjunct (the location time of the verb has to be temporally included in the time indicated by the adjunct) is combined with the following constraint which applies to all verbal signs, and with the one below it, which applies specifically to eventuality indices of the *telic* type. The first implicational constraint says that for all eventualities i their eventuality time z should merely overlap their location time t ; the second one narrows this down to a subtype of the overlap relation, namely inclusion, for eventualities of the event class.

IC-VERB

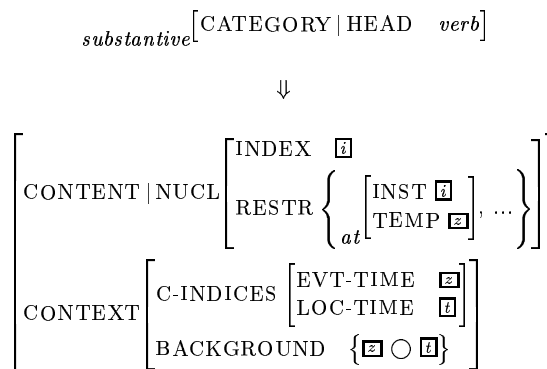

IC-EVENT

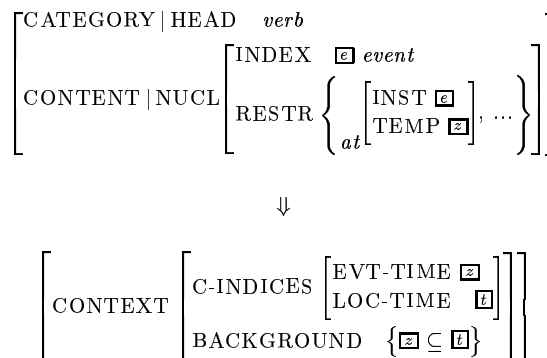

In Kamp & Reyle 1993, the denotation of the 'real' frame adjuncts is simply *identified* with the verb's location time. However, imposing the less strict relation of inclusion allows for an easy analysis of sentences in which several frame adjuncts are present and with no obvious scope ambiguities as a result.

- (9) Ik was vorig jaar in Rome in oktober.
I was last year in Rome in October
"Last year, I was in Rome in October."

Both adjuncts (*vorig jaar* (*last year*) and *in oktober* (*in October*)) impose an inclusion relation upon the verb's location time without resulting in a contradiction. If both would *completely* specify the location time, as in Kamp & Reyle's proposal, this would be far less obvious.

4.2.2 Other relations

But of course the relation between the time denoted by the adjunct and the verb's location time need not always be inclusion. Adjuncts

headed by the prepositions *na* (*after*) and *voor* (*before*), for example, do not provide a frame, but merely indicate that the verb's location time is to be situated *after* or *before* the period of time which is the complement of the preposition. In this sense, adjuncts like *na gisteren* (*after yesterday*) restrict their eventuality's location time to a much lesser degree than the 'real' frame adjuncts.

By way of illustration, here is the result of the combination of the AVMs for *na* (*after*) and *gisteren* (*yesterday*).

NA GISTEREN

$$\left[\begin{array}{l} \text{CAT} \left[\begin{array}{l} \text{HEAD} \left[\begin{array}{l} \text{MOD} \left[\begin{array}{l} \text{CATEGORY} | \text{HEAD } \textit{verb} \\ \text{CONX} | \text{C-INDS} | \text{LOC-TIME } [t] \end{array} \right] \\ \textit{prep} \\ \text{SUBCAT } \langle \rangle \end{array} \right] \end{array} \right] \\ \\ \text{CONT} | \text{NUCL} \left[\begin{array}{l} \text{PRED} \left[\begin{array}{l} \text{ARG1 } [t] \\ \text{ARG2 } [x] \textit{ yesterday} \end{array} \right] \\ \textit{after} \\ \text{RESTR } \{ \} \end{array} \right] \\ \\ \text{CONX} \left[\begin{array}{l} \text{C-INDS} | \text{UTT-LOC } [u] \\ \text{BACK} \left\{ \begin{array}{l} \textit{day} [\text{INST } [d]], [x] \subseteq [d], [x] = [d] - 1, \\ [x] \prec [t] \end{array} \right\} \end{array} \right] \end{array} \right] \end{array} \right]$$

The index x is provided by *gisteren*; the index t is the location time of the verb modified by the preposition. The value for CONX|BACK is obtained through union of the set of restrictions associated with non-adjunctive *gisteren* (there is a day d which is the day of utterance, and *yesterday* is one unit in the past from this particular day) and the set provided by *na* (the location time t is preceded by the index of the argument of the preposition).

4.3 Which index is being modified?

It has often been observed that adjuncts of the kind *om x uur* (*at x o'clock*) are not quite like the locating adjuncts discussed so far. Traditionally, this is ascribed to their so-called *point-like* nature. Within our approach, the exceptional character of this locating adjunct (after all, it still is a legitimize answer to the question *when?*) becomes apparent by the fact that it does not only express a restriction upon the location time, but also on the temporal dimension of the eventuality itself, its eventuality time.

Suppose we would let *om twee uur* (*at two*

o'clock) modify only the location time. The most severe restriction we would be able to formulate, would be that the index corresponding to the small period of time denoted by two o'clock (and perhaps thereabouts) has to be identified with the location time. That would give a satisfying result with atelic eventualities (which only have to overlap their location time), but would be overly restrictive in the case of telic eventualities—the whole of an event like for instance buying a car would be situated within two o'clock, which clearly runs counter to our intuition.

Loosening up the constraint to inclusion of the index of the adjunct within the location time of the verb modified, would work for the telic eventualities, but would end up generating interpretations in which the eventuality is not even going on at the time indicated by the adjunct in combination with atelic eventualities.

This led us to assume that adjuncts like *om twee uur* have an influence on *both* the eventuality time and the location time. In the AVM below, the index x which is associated with the argument of the preposition *at*, and which functions as a placeholder for the small period of time introduced by *two o'clock*, is constrained to be temporally included within the index of the eventuality time (z) and the location time (t).

OM TWEE UUR

$$\left[\begin{array}{l} \text{CAT} \left[\begin{array}{l} \text{HEAD} \left[\begin{array}{l} \text{MOD} \left[\begin{array}{l} \text{CAT} | \text{HEAD } \textit{verb} \\ \text{CX} | \text{C-INDS} \left[\begin{array}{l} \text{EVT-TIME } [z] \\ \text{LOC-TIME } [t] \end{array} \right] \end{array} \right] \\ \textit{prep} \end{array} \right] \end{array} \right] \\ \\ \text{CONT} | \text{NUCL} \left[\begin{array}{l} \text{PRED} \left[\begin{array}{l} \text{ARG1 } [z] \\ \text{ARG2 } [x] \end{array} \right] \\ \textit{at} \\ \text{RESTR } \{ \} \end{array} \right] \\ \\ \text{CONX} | \text{BACK} \left\{ [z] \subseteq [z], [z] \subseteq [t] \right\} \end{array} \right] \end{array} \right]$$

Note that the constraint on the location time is *also* indispensable. Leaving it out would lead to unwanted interpretations. For instance, in (10), the past tense requires the location time to precede the utterance time; the aspectual constraint pertaining to the relation between an atelic eventuality's eventuality time and its location time specifies merely that the state of being at home should overlap its location time;

if two o'clock only has to be included within the eventuality time, it would be left unresolved whether two o'clock lies in the past or the future with respect to the utterance time, although we obviously want it to be situated on the same side of the utterance time as the location time. In other words, we have to assume that *om 2 uur* formulates constraints on both the eventuality time itself and the location time if we want to exclude the interpretation for (10) with two o'clock situated after the utterance time (depicted below), which is simply unavailable.

- (10) Ik was thuis om twee uur.
 I was home at two o'clock
 "At two o'clock, I was at home."

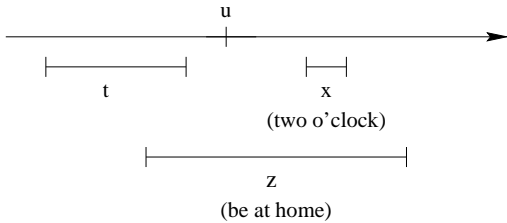

Interestingly, when analyzed in the way we do, *om x uur* adjuncts seem to fall somewhere in between the other locating adjuncts and the durational adjuncts, which we will discuss in the next section.

5 Durational adjuncts

Our analysis of the durational adjuncts is rather straightforward. There are two classes: the *in-adjuncts*, which can only combine with eventualities of the *event* type, and the *for-adjuncts*, which can only modify eventualities of the *state* or *process* type (the atelic eventualities).

The amount of time introduced by *in-adjuncts* like for instance *in een oogwenk* (*in an instant*), *in minder dan een week* (*in less than a week*) and *in twee uur* (*in two hours*), is the *maximum* duration of the event being modified.

This is represented by means of a CONTEXT|BACKGROUND restriction to the effect that the index denoting the eventuality time can be included within the index (*x*) of the period of time which is the argument of the preposition *in*.

Note that, again, the issue of which of the verb's indices is being modified by the adjunct

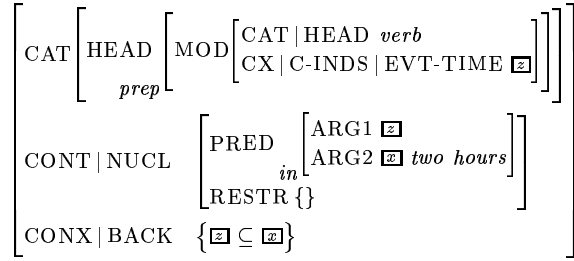

is of major importance. In the case of the *in-adjuncts*, it is the index of the eventuality time itself.

For-adjuncts like *twee uur* (*for two hours*), *de hele nacht lang* (*all night long*) and *een week* (*for a week*) express the *minimum* amount of time the atelic eventuality takes, and impose the opposite condition upon the eventuality time index of the eventuality they modify: the index of the period of time associated with the adjunct has to be temporally included within it. But there is also a constraint on the relation between the eventuality time and the location time, in order to rule out unwanted interpretations, like the one depicted for (11).

- (11) Het regende twee dagen.
 It rained two days
 "It rained for two days."

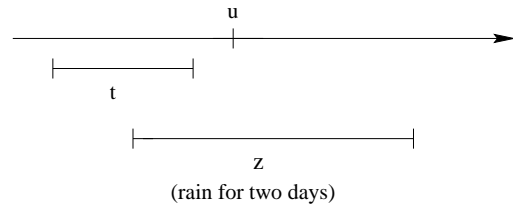

The past tense requires the location time to precede the utterance time; and the raining has to last for at least two days. Nothing precludes this two day raining period from being not entirely situated in the past, which is clearly not as wanted.

It turns out that exactly the same relation between the eventuality time and the location time is required as the one which usually applies to telic eventualities only: the index of the eventuality time has to be temporally included within

the location time. That makes sense, as *for*-adjuncts are often called *aspectual* in nature—they impose event-like characteristics on processes or states. By letting *for*-adjuncts simply introduce this constraint, we can take care of the aspectual effect of the presence of *for*-adjuncts without much further ado.³ We illustrate this with the AVM for *een dag* (*for a day*).

EEN DAG

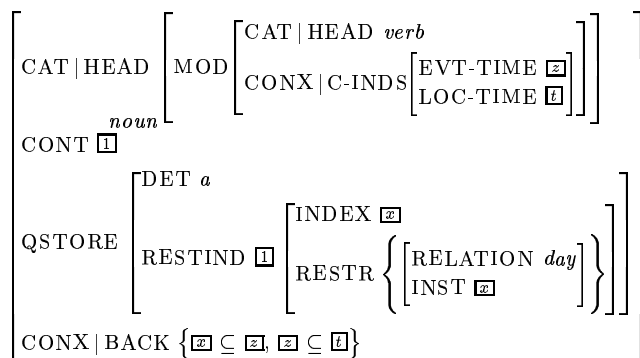

Our analysis of the durational adjuncts accounts nicely for the following facts:

- (12) Ik heb in een uur een verhandeling geschreven; ik heb het zelfs in drie kwartier gedaan.
I have in an hour a paper written; I have it even in three quarters done.
“I have written a paper in an hour; I have even done it within three quarters of an hour.”
- (13) *Ik heb in een uur een verhandeling geschreven; ik heb het zelfs in een uur en een kwartier gedaan.
I have in an hour a paper written; I have it even in an hour and a quarter done.
“I have written a paper in an hour; I have even done it in an hour and a quarter.”
- (14) Ja, ik heb acht uur geslapen; ik heb zelfs tien uur geslapen.
Yes, I have eight hours slept; I have even ten hours slept.

³The aspectual effect of the past participle is dealt with by the same means: the eventuality time (whether belonging to a telic or an atelic eventuality) is simply required to be included in the location time.

“Yes, I slept for eight hours; I even slept for ten hours.”

- (15) *Ja, ik heb acht uur geslapen; ik heb zelfs zeven uur geslapen.
Yes I have eight hours slept; I have even seven hours slept.

“Yes, I slept for eight hours; I even slept for seven hours.”

To wrap things up, the following example shows that our representation of the semantics of temporal adjuncts automatically generates the desirable interpretation of a sentence in which a locating adjunct and a *for*-adjunct are combined.

- (16) Ik was gisteren twee uur thuis.
I was yesterday two hours home.
“Yesterday, I was at home for two hours.”

The following constraints are being imposed:

- The verb
 - introduces a state a ,
 - introduces the eventuality time associated with it, z
 - is subject to the general constraint for verbal signs to the effect that this eventuality time overlaps the location time t ($z \circ t$)
- The past tense requires the state’s location time to temporally precede the utterance time ($t \prec u$)
- The *for*-adjunct
 - expresses that the state lasts at least for two hours—its eventuality time should extend beyond that period of time x ($x \subseteq z$)
 - has an aspectual effect by requiring that the state’s temporal extension should be temporally included in its location time ($z \subseteq t$)
- The locating adjunct restricts the state’s location time to fall within yesterday ($t \subseteq y$)

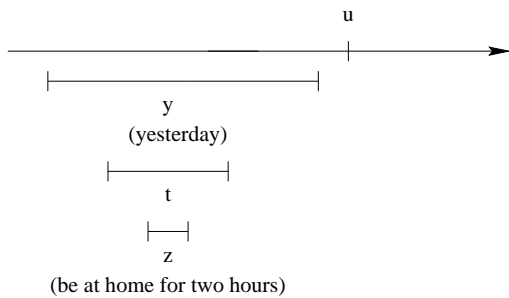

This leads to the following correct interpretation:

And it is easy to see why (17) will rightfully be rejected:

- (17) *Ik heb gisteren achtenveertig
 I have yesterday for
 uur gewandeld.
 forty-eight hours walked
 “Yesterday, I walked for forty-eight
 hours.”

6 Conclusion

We hope to have demonstrated that we are able to construct a semantic analysis for a wide range of temporal adjuncts by closely examining quite a number of relations:

- the relation between the index of the temporal adjunct and the time axis (mediated or not; mediated by the utterance time or by another temporal anchor)(section 4.1)
- the relation between the index of the period of time introduced by the temporal adjunct and the location time associated with the eventuality it modifies (section 4.2)
- the relation between the index of the period of time introduced by the adjunct and the index of the eventuality time (section 4.3 and 5)
- the relation between the eventuality time and the location time (section 5)

Moreover, we have shown how such a semantic analysis can be integrated into standard HPSG, and illustrated how it can elegantly account for a number of data.

References

- Emmon Bach. 1981. On Time, Tense and Aspect: an Essay in English Metaphysics. In P. Cole, editor, *Radical Pragmatics*. Academic Press New York.
- Michael Bennett and Barbara Partee. 1978. Toward the Logic of Tense and Aspect in English. Bloomington: Indiana University Linguistics Club. Revision of 1972 ms.
- Robert I. Binnick. 1991. *Time and the Verb*. Oxford University Press.
- Patrick Blackburn. 1994. Tense, Temporal Reference, and Tense Logic. *Journal of Semantics*, 11:83–101.
- Elisabet Engdahl. 1999. Integrating pragmatics into the grammar. In L. Mereu, editor, *Boundaries of Morphology and Syntax*. John Benjamins, Amsterdam.
- Georgia Green. 1994. The structure of CONTEXT: The representation of pragmatic restrictions in HPSG. *Studies in the Linguistic Sciences*, 24(1-2):215–232.
- Erhard Hinrichs. 1986. Temporal Anaphora in Discourses of English. *Linguistics and Philosophy*, 9:63–82.
- Hans Kamp and Uwe Reyle. 1993. *From Discourse to Logic*. Kluwer Academic Publishers.
- Robert Kasper. 1994. Adjuncts in the Mittelfeld. In J. Nerbonne, K. Netter, and C. Pollard, editors, *German in Head-driven Phrase Structure Grammar*, number 46 in CSLI Lecture Notes. CSLI, Stanford.
- E. Oversteegen. 1988. Temporal Adverbials in the Two Track Theory of Time. In V. Ehrich and H. Vater, editors, *Temporalsemantik*, number 201 in *Linguistische Arbeiten*. Niemeyer Tübingen.
- Barbara Partee. 1984. Nominal and Temporal Anaphora. *Linguistics and Philosophy*, 7:243–286.
- Carl Pollard and Ivan A. Sag. 1994. *Head-driven Phrase Structure Grammar*. The University of Chicago Press.
- Carlota S. Smith. 1981. Semantic and Syntactic Constraints on Temporal Interpretation. In P. Tedeschi and A. Zaenen, editors, *Tense and Aspect*, volume 14 of *Syntax and Semantics*. Academic Press, New York.
- Frank Van Eynde. 1998. Tense, Aspect

and Negation. In F. Van Eynde and P. Schmidt, editors, *Linguistic Specifications for Typed Feature Structure Formalisms*. European Communities.

Frank Van Eynde. 2000. Figure Heads in HPSG. In F. Van Eynde, I. Schuurman, and N. Schelkens, editors, *Computational Linguistics in the Netherlands 1998*, number 29 in Language and Computers: Studies in Practical Linguistics. Rodopi, Amsterdam.